

2459-13 DE-22b)

F116

**English translation of
the Japanese patent
nr. 7-300979**

Japanese Unexamined Patent Publication No. 7-300979

Publication Date: November 14, 1995

Application No.: 6-116024

Application Date: May 2, 1994

Inventor: Konishi et al.

Applicant: Daiken Kogyo Co., Ltd.

Title of the Invention: Floor material

[Abstract]

[Object] To provide a laid floor material which can be installed with high precision, without exhibiting offsets or gaps between pieces of floor material neighboring in the forward and rear, and right and left directions.

[Configuration]

A groove 2 having a fitting groove 2b opening upwards is formed on the upper plane of one long side edge of a rectangular piece of floor material 1, a tongue 3 having a downward-facing protrusion 3d capable of engaging the above fitting groove 2b is formed on the lower plane of the other long side edge, whereby floating or offsets of neighboring main floor material pieces 1 and 1 does not occur due to the engaging of the tongue and groove portions 2 and 3, and also, width-wise shifting is restricted by engaging of the fitting groove 2b and protrusion 3d, doing away with gaps emerging. Also, mutually-engaging upward-facing retaining hooks 4 and

downward-facing retaining hooks 5 are formed on the short ends of the main floor material 1, so that the floor material pieces 1 and 1 can be linked in a direction at right angles with the above fitting of the tongue and groove portions 2 and 3, and the engaging of the hooks 4 and 5 restrict length-wise shifting.

Claims:

1. Floor material, wherein one set of opposing and parallel ends of main floor material formed in a plane quadrangle shape each comprise a tongue having an engaging protrusion erected on the lower plane and a groove having an fitting groove portion formed so as to be fittable with said engaging protrusion on the upper plane, and wherein the other set of opposing and parallel ends each comprise an upward-facing retaining hook with a retaining protrusion provided to the tip of a notched step notched in an L-shaped cross-sectional form at the upper plane thereof and a downward-facing retaining hook with a retaining groove of a shape capable of fitting with said retaining protrusion formed at the base of a notched portion notched in a reverse-L-shaped cross-sectional form at the lower plane thereof.
2. Floor material, comprising main floor material formed of a plurality of floorboard pieces formed in a long plane

quadrangle shape and integrally aligned en echelon with the sides thereof brought into contact with one another, wherein one set of opposing and parallel ends thereof on at least the outmost side each comprise a tongue having an engaging protrusion erected on the lower plane and a groove having an fitting groove portion formed so as to be fittable with said engaging protrusion on the upper plane, and wherein the other set of opposing and parallel stepped ends each comprise an upward-facing retaining hook with a retaining protrusion provided to the tip of a notched step notched in an L-shaped cross-sectional form at the upper plane thereof and a downward-facing retaining hook with a retaining groove of a shape capable of fitting with said retaining protrusion formed at the base of a notched portion notched in a reverse-L-shaped cross-sectional form at the lower plane thereof.

3. Floor material, having a construction wherein a flexible base material is integrally layered on the lower plane of main floor material, wherein said flexible base material forms the engaging protrusion of said tongue and the fitting groove of said groove, and said upward-facing retaining hook and the retaining groove of said downward-facing retaining hook.

Detailed Description of the Invention

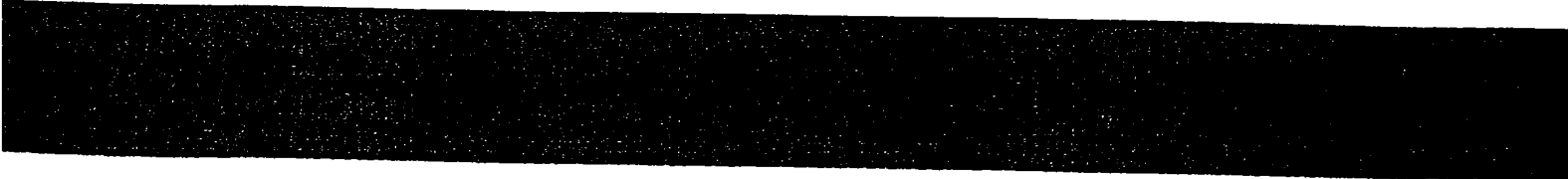

[0001]

Field of the Invention

The present invention relates to a laid floor material which is installed without using nails or adhesive agents.

[0002]

Description of the Related Art

Conventionally, floor material, wherein a tongue is erected on one side and a groove capable of fitting with the tongue is formed on the other side of rectangle-shaped main floor material pieces, is widely known for floor material laid on a sub-floor such as plywood or concrete slab. However, with such floor material, the tongue and the groove portions on the opposing sides of the floor material are simply brought into tongue-and-groove contact one with another, and there is no restriction along the sub-floor in the direction of the pieces moving away from one another, so gaps and offsets easily occurred between the neighboring piece of floor material depending on the skill of the worker and irregularities in precision of the worked planes of the material.

[0003]

Accordingly the present Applicant has developed the floor material disclosed in Japanese Patent Application 4-317769. That is, regarding both opposing and parallel side edges of this floor material, a tongue portion is formed by

forming a groove opening in the horizontal direction and a groove opening in the vertical downwards direction on the tip one side end and the base lower plane respectively, a groove portion is formed by forming on the tip lower portion and base edge of the other side edge an upwards-facing protrusion capable of engaging the groove opening in the vertical downwards direction and a horizontal protrusion capable of fitting with the groove opening in the horizontal direction, thus having a tongue-and-groove structure, wherein, in the event of bringing the tongue-and-groove portions of the neighboring floor material pieces being laid into contact, the groove opening in the horizontal direction and the horizontal tongue being engaged restricts vertical shifting, while the groove opening in the vertical downwards direction and upwards-facing protrusion being fit restricts horizontal shifting.

[0004]

Problems to be Solved by the Invention

However, this structure has had problems, in that in the event that the floor material is laid on the sub-floor surface without using nails or adhesive agents, even though shifting can be restricted between the one set of opposing and parallel ends, the other set of opposing and parallel ends are simply abutted without any confinement, so outward force due to walking, earthquakes, etc., can cause slippage

between the sub-floor surface and the floorboards, or gaps may occur between the abutted edges due to absorption and release of moisture and the like, meaning that a floor with good precision could not be obtained.

[0005]

Such problems would seem to be solved by also providing the abutting edges of the floor material with the same sort of tongue-and-groove construction as above, but in this case, the tongue neighboring the right angle of the floor material next to the tongue neighboring the right angle exposed at the reentrant angle of an already-laid row of floor material cannot be fit in. That is, in regard to one tongue at the tongue portion neighboring the right angle exposed at the reentrant angle of the floor material, even in the event that one attempts to incline the floor material to fit the tongue portion and the lower inclined end thereof and then lower this floor material onto the sub-floor so as to fit the neighboring other tongue-and-grooves, the horizontal protrusion of one tongue portion strikes against the tongue portion of the other, thus restricting any further movement, so this work cannot be performed in reality. It has particularly been difficult to fit the stepped end portions of floor material formed of a plurality of floorboard pieces formed in a plane quadrangle shape and integrally aligned en echelon with the sides thereof brought into contact with one

another.

[0006]

The present invention has been made in light of the above, and it is an object thereof to provide a floor material which has a structure that does not shift forwards, backwards, right or left on the sub-floor, and which can be laid easily and precisely.

[0007]

In order to achieve the above objects, floor material formed with the front and rear ends and right and left ends each being parallel to one another, is formed such that one set of opposing and parallel ends of main floor material formed in a plane quadrangle shape each comprise a tongue having an engaging protrusion erected on the lower plane and a groove having an fitting groove portion formed so as to be fittable with the engaging protrusion on the upper plane, and such that the other set of opposing and parallel ends each comprise an upward-facing retaining hook with a retaining protrusion provided to the tip of a notched step notched in an L-shaped cross-sectional form at the upper plane thereof and a downward-facing retaining hook with a retaining groove of a shape capable of fitting with the retaining protrusion formed at the base of a notched portion notched in a reverse-L-shaped cross-sectional form at the lower plane thereof.

[0008]

According to the invention in Claim 2, floor material which comprises main floor material formed of a plurality of floorboard pieces formed in a plane quadrangle shape and integrally aligned en echelon with the sides thereof brought into contact with one another, is arranged such that one set of opposing and parallel ends thereof on at least the outmost side each comprise a tongue having an engaging protrusion erected on the lower plane and a groove having an fitting groove portion formed so as to be fittable with the engaging protrusion on the upper plane, and such that the other set of opposing and parallel stepped ends each comprise an upward-facing retaining hook with a retaining protrusion provided to the tip of a notched step notched in an L-shaped cross-sectional form at the upper plane thereof and a downward-facing retaining hook with a retaining groove of a shape capable of fitting with the retaining protrusion formed at the base of a notched portion notched in a reverse-L-shaped cross-sectional form at the lower plane thereof.

[0009]

Further, according to the invention in the third Claim, floor material which has a construction wherein a flexible base material is integrally layered on the lower plane of main floor material, is arranged such that the flexible base

material forms the engaging protrusion of the tongue and the fitting groove of the groove, and the upward-facing retaining hook and the retaining groove of the downward-facing retaining hook.

[0010]

[Operation]

In the event of laying the floor material having the above structure on a sub-floor surface, without using nails or adhesive agent, in order to fit the hook and tongue neighboring the right angle exposed at the reentrant angle of an already-laid row of floor material, i.e., in order to fit the downward-facing retaining hook and the tongue neighboring the right angle of the floor material to be laid next with the groove and upward-facing retaining hook each provided to the rear edge plane of floor material at the forward row and one side edge of the floor material being laid at the rear side, the tongue of the floor material to be laid is fit into the groove provided to the rear end plane of the floor material laid at the front row side, with the floor material in an inclined state, from which gradually laying the floor material down gradually fits the retaining protrusion provided on the tongue with the fitting groove formed on the groove portion, while the downward-facing retaining hook provided on the opposing side edge of the floor material fits with the upward-facing retaining

hook provided on the one edge side of the floor material already laid at the front row side.

[0011]

Also, according to the invention described in Claim 2, the downward-facing retaining hook of the floor material to be subsequently laid is fit with the upward-facing hook provided to the reentrant angle of the multiple pieces of already laid floor material, at one side edge plane formed in a stepped form, and thus is installed.

[0012]

Following laying, the mutually fit tongue-and-groove portions confine shifting in the vertical direction such as floating of the floor material, and fitting of the upward-facing retaining hook and the downward-facing retaining hook mutually confine movement in the left and right directions, so there is no worry of gaps emerging. Also, according to the invention described in Claim 3, the groove and protrusion of the tongue-and-groove, and upward-facing retaining hook and the downward-facing retaining hook each have flexibility, so as to easily deform and smoothly fit one another, which improves ease of installation.

[0013]

[Embodiments]

Making description of an embodiment of the present invention with reference to the drawings, reference numeral

1 denotes main floor material having a constant width and length, formed of plywood, particle board, MDF, or other likewise wood material, wherein with the mutually parallel long-side edges as the front and rear edge planes, the front edge plane has a groove 2 and the rear edge has a tongue 3, while with the mutually parallel ends on the short side as the left and right edges, one side edge plane has an upward-facing retaining hook 4, and the other side edge plane has a downward-facing retaining hook 5 having a form which can be fit with the upward-facing retaining hook 4.

[0014]

Making specific description of the above tongue-and-groove portions 2 and 3, and the upward-facing retaining hook 4 and downward-facing retaining hook 5, as shown in Fig. 2, the groove 2 is formed of a groove 2a formed opening toward the front direction by being cutting out a portion of a certain thickness at the center of the front edge side of the main floor material 1 from the front side inwards; and at the top and bottom horizontal protrusions 2b and 2c protruding forwards from the far side of this groove 2a, the front edge portion of the protrusion 2b at the top side is cut by a certain width so as to form the protruding length of the protrusion 2b shorter, while a fitting groove 21d opening upwards at the front side of the protruding edge plane of the top protrusion 2b is formed at the upper plane

center portion of the bottom protrusion 2c.

[0015]

The tongue 3 is formed of a tongue 3a erected on the rear edge plane center portion of the floor material 1, horizontally toward the rear side with a length which is generally the same protruding length as the top protrusion 2b of the groove 2 or slightly shorter, wherein the thickness of this protrusion 3a is formed to a thickness which can be fit into the horizontal groove 2a of the above groove 2 and the lower plane side of the protrusion 3a is notched in a reverse-L-shaped cross-section form at a width generally the same as the protruding width of the lower protrusion 2c of the above groove 2, and an engaging protrusion 3c capable of fitting to the fitting groove 2d of the groove 2 erected in a downward-facing direction at the middle portion of the lower plane of the protrusion 3a formed by this notched portion 3b.

[0016]

Also, at the mutually parallel short end side of the main floor material 1, the upward-facing retaining hook 4 formed at one side edge plane, a notched step portion 4a is formed in an L-shaped cross-section over the entire width of a certain length portion on the upper half portion of one side edge of the main floor material, and a groove 4b reaching a certain depth is cut out from the upper plane of

the base portion of this notched step portion 4a, thereby forming a retaining protrusion 4c at the tip edge portion, while a downward-facing step portion 5a is formed by notching in an reverse-L-shaped cross-section over the entire width of a portion of generally the same length as the notched dimensions of the above notched step portion 4a on the lower half portion of the other side edge of the main floor material 1, and a groove 5b reaching a certain depth is cut out from the lower plane of the base portion of this notched step portion 5a, also forming a retaining protrusion 5c at the tip edge portion.

[0017]

Now, making description regarding the procedures for laying the floor material thus configured on a sub-floor A, as shown in Fig. 4 and Fig. 5, the main floor material pieces 1 and 1 are sequentially linked in the longitudinal direction by opposing upward-facing retaining hooks 4 and downward-facing retaining hooks 5 being engaged, and thus laid, and in the width direction, as shown in Fig. 6, the tongue-and-groove portions 2 and 3 form on the ling side of the front and rear sides of the main floor material pieces 1 and 1 are mutually engaged, thus being laid in a sequentially linked state.

[0018]

At this time, the arrangement is such that the main

floor material pieces 1 are laid in the length direction in a straight row, following which the main floor material pieces 1 are laid for the next row, and accordingly, the groove 2 of the rear long side edge exposed on the already-lain former row of main floor material pieces 1, and the upward-facing retaining hook 4 exposed at one edge side of the main floor material pieces 1 laid as a next row linking to this groove 2 at a right angle, are engaged with the tongue 3 of the front long side edge and the downward-facing retaining hook 5, thereby installing the main floor material pieces 1. Thus, main floor material pieces 1 can be sequentially installed without using nails or adhesive agents, by forming right-angle reentrant angles between the grooves 2 of the main floor material pieces 1 and the upward-facing retaining hooks 4 of the main floor material pieces 1.

[0019]

In order to perform this work, first, the main floor material piece 1 to be laid is inclined such that the tongue 2 side is downwards, the protrusion 3a of the tongue 3 is fit to the opening end of the groove 2a of the groove 2 of the main floor material piece 1 of the front row side, and the main floor material piece 1 to be laid is moved in the longitudinal direction following the groove 2a, thereby causing the downward-facing retaining hook 5 of the short

side linked to the tongue 3 at right angles to face the upward-facing retaining hook 4.

[0020]

From this state, the main floor material piece 1 to be laid is lowered in the horizontal direction, while pressing the protrusion 3a of the tongue 3 into the groove 2a of the groove 2 of the main floor material piece 1, whereby the tip retaining protrusion 5c of the lower-facing retaining hook 5 gradually fits with the groove 4b of the upward-facing retaining hook 4 in the rearward direction, and also the engaging protrusion 3c erected on the lower plane of the tongue 3 fits into the fitting groove 2d of the groove 2, and the main floor material piece 1 is laid on the sub-floor A in this state.

[0021]

The above work is repeatedly performed so as to lay a floor of a great number of rows of floor material on the sub-floor A, and following installation, vertical movement between the main floor material pieces 1 and 1 such as floating is confined by the mutually-engaged tongue-and-grooves 2 and 3, forward and backward movement is confined by the mutually-engaged groove 2d and protrusion 3c of the tongue-and-grooves 2 and 3 as shown in Fig. 7, and further, as shown in Fig. 8, shifting in the left and right directions (longitudinal direction of the row) is prevented

by the upward-facing retaining hook 4 and downward-facing retaining hook 5 being engaged.

[0022]

Incidentally, an elastic layer of a rubber layer or the like having an appropriate thickness may be placed on the bottom side of the floor material 1 in the above embodiment, and further, an appropriate decorative layer may be applied on the top surface thereof.

[0023]

Next, an embodiment of the invention described in Claim 2 will be described based on Fig. 9 and Fig. 10. The floor material 1 is formed of a plurality of floorboard pieces 1a, 1b, 1a formed in a long plane quadrangle shape and integrally aligned en echelon with the longer sides thereof brought into contact with one another, and in the present embodiment, these are integrally linked by a backing material 1c such as plywood, particle board, resin plate, paper, cloth, non-woven fabric, rubber, resin foam sheeting, etc. Also, at the time of integral forming, the sides of the floorboard pieces 1a and 1b may be fixed with an adhesive agent, or forming a tongue-and-groove structure on the sides of the centrally-positioned floorboard piece 1b so as to fit the likewise-formed outward-most floorboard pieces 1a and 1a.

[0024]

Then, the parallel edge planes 2 and 3 of at least the outward-most floorboard pieces 1a and 1a are provided with a tongue 3 having a retaining protrusion 3c and a groove 2 having a fitting groove 2d, as with the first embodiment. At the other mutually parallel stepped ends 4a and 5a are provided upward-facing retaining hooks 4 and downward-facing retaining hooks 5, as with the embodiment of the above invention described in Claim 1. Incidentally, the end planes 4b and 5b which meet the stepped end planes 4a and 5a are formed flat in the present embodiment, but in the event of fitting and connecting the floorboard pieces 1a and 1b by tongue-and-groove working as described in the above variation, the tongue thereof is exposed at the end planes 4b and 5b. According to the present embodiment, the abutting end plane is in a stepped form, so joints and gaps are less obvious.

[0025]

Next, Fig. 11 through Fig. 15 illustrate a further embodiment of the present invention, and though the main floor material 1 above is formed of a wood material, the main floor material 1A according to the present embodiment has the upper half portion 1a formed of a wood material and the lower half portion 1b thereof formed of a flexible sheet, with these both being integrally layered and fixed by adhesion. The forms of the tongue-and-groove portions 2 and

3, the upward-facing retaining hook 4 and downward-facing retaining hook 5 formed on the edges on the four sides are the same as with the main floor material 1 described in the above embodiment, so detailed description thereof will be omitted, but as shown in fig. 12 and Fig. 13, the horizontal protrusion 2c at the lower side of the groove 2 and the fitting groove 2d, and the lower layer portion of the notch 3b of the tongue 3 and the engaging protrusion 3c protruding downwards from this lower layer portion are formed of a flexible sheet, and further, the entirety of the upward-facing retaining hook 4 provided on the short side is formed of a flexible sheet, and the opposing inner surface of the retaining groove of the downward-facing retaining hook 5 and the tip retaining protrusion 5c thereof are formed of a flexible sheet. Incidentally, the flexible sheet used is a sheet material such as rubber or an elastic resin sheet, having flexibility and also elastic deformability.

[0026]

The method of installing this main floor material 1A is the same as the above embodiments, but the lower side horizontal protrusion 2c of the groove 2 is formed of a flexible sheet, so at the time of fitting with the tongue 3 of the main floor material 1A to be installed to this groove 2, the horizontal protrusion 2c is compressed and deformed by the pressing force of the tongue 3 and the engaging

protrusion 3c is thus smoothly fit into the fitting groove 2d, while the tongue which has fit with the groove 2a of the groove 2 by is pressed upwards by the resilience of the horizontal protrusion 2c such that the upper plane thereof comes into pressed contact with the lower plane of the upper side protrusion 2b of the groove 2, consequently allowing the upper plane of the main floor material 1A and 1A to be laid as a single plane.

[0027]

In the same way, the downward-facing retaining hook 5 also is compressed and deformed according to the pressing of the upward-facing retaining hook 4 so the hooks 4 and 5 can be smoothly engaged. Incidentally, in the above embodiments, the tongue-and-groove 2 and 3 are provided to the long sides of the main floor material 1 and 1A, and the hooks 4 and 5 are provided to the short sides thereof, but an arrangement may be made wherein the tongue-and-groove 2 and 3 are provided to the short sides and the hooks 4 and 5 are provided to the long sides; further, the main floor material 1 and 1A may be formed as true squares.

[0028]

[Advantages]

According to the floor material of the present invention described above, floor material formed with the front and rear ends and right and left ends each being

parallel to one another, is formed such that one set of opposing and parallel ends of main floor material formed in a plane quadrangle shape each comprise a tongue having an engaging protrusion erected on the lower plane and a groove having an fitting groove portion formed so as to be fittable with the engaging protrusion on the upper plane, and such that the other set of opposing and parallel ends each comprise an upward-facing retaining hook with a retaining protrusion provided to the tip of a notched step notched in an L-shaped cross-sectional form at the upper plane thereof and a downward-facing retaining hook with a retaining groove of a shape capable of fitting with the retaining protrusion formed at the base of a notched portion notched in a reverse-L-shaped cross-sectional form at the lower plane thereof, so the tongue of the main floor material to be laid next is fit into the tongue of the main floor material of the row already laid, and the downward-facing retaining hook is engaged with the upward-facing retaining hook of the main floor material lead in the next row linked at right angles with the groove, so the main floor material can be installed in an easy and precise manner.

[0029]

Further, vertical shifting such as floating or offsets between neighboring pieces of floor material can be prevented by the mutually fit tongue-and-groove portions,

forward and rear movement can be confined in a sure manner by the mutually-engaged groove of the upward-facing opening and downward-facing protrusion of the tongue-and-groove portions, and further, right and left shifting is confined by upward-facing hook portion linked at right angles to the tongue-and-groove portions engaging the downward-facing hook portion, so a precise installation state can be maintained over long periods of time, without gaps occurring between the pieces of floor material due to earthquakes and the like.

[0030]

Also, according to the invention described in Claim 2, main floor material is formed of a plurality of floorboard pieces formed in a long plane quadrangle shape and integrally aligned en echelon with the sides thereof brought into contact with one another, so the abutting portion of the main floor material is linked by engaging the stepped upward-facing retaining hooks and the downward-facing retaining hooks, thus enabling floor installation wherein gaps and joints are not evident.

[0031]

Further, forming the mutually engaging groove and protrusion and upward-facing hooks and the downward-facing hooks of a flexible material, the pieces can be fit and engaged while being deformed at the time of installation, thus further improving installability, and also providing

the floor material with appropriate cushioning providing resilience, so that even in the event that there is some unevenness on the sub-floor or irregularities in the installation skills, this can be absorbed, and precise floor installation with a single upper plane can be performed. Thus, the present invention provides a floor material which is laid on a sub-floor without using nails or adhesive agents, and which can be precisely and easily installed without requiring skill.

[Brief Description of the Drawings]

[Fig. 1] Fig. 1 is a plan view of the floor material according to the present invention.

[Fig. 2] Fig. 2 is an enlarged cross-sectional view along line Y-Y thereof.

[Fig. 3] Fig. 3 is an enlarged cross-sectional view along line X-X thereof.

[Fig. 4] Fig. 4 is a simplified perspective view of the state of installation.

[Fig. 5] Fig. 5 is a perspective view of a cross-section of one portion in order to describe the engaged state of the tongue and groove portions.

[Fig. 6] Fig. 6 is a perspective view of a cross-section of one portion in order to describe the engaged state of the hooks.

[Fig. 7] Fig. 7 is a partial cross-section view to describe

the engaged state of the tongue and groove portions of neighboring floor material.

[Fig. 8] Fig. 8 is a partial cross-section view to describe the engaged state of the hooks of neighboring floor material.

[Fig. 9] Fig. 9 is a simplified plan view showing another embodiment of the present invention.

[Fig. 10] Fig. 10 is an enlarged cross-sectional view along line Y-Y thereof.

[Fig. 11] Fig. 11 is a simplified plan view showing yet another embodiment of the present invention.

[Fig. 12] Fig. 12 is an enlarged cross-sectional view along line Y-Y thereof.

[Fig. 13] Fig. 13 is an enlarged cross-sectional view along line X-X thereof.

[Fig. 14] Fig. 14 is a partial cross-section view to describe the engaged state of the tongue and groove portions of neighboring floor material.

[Fig. 15] Fig. 15 is a partial cross-section view to describe the engaged state of the hooks of neighboring floor material.

[Reference Numerals]

- 1 Main floor material
- 2 Groove
- 2d Fitting groove
- 3 Tongue
- 3c Engaging protrusion

- 4 Upward-facing retaining hook
- 4c Retaining protrusion
- 5 Downward-facing retaining hook
- 5b Retaining groove

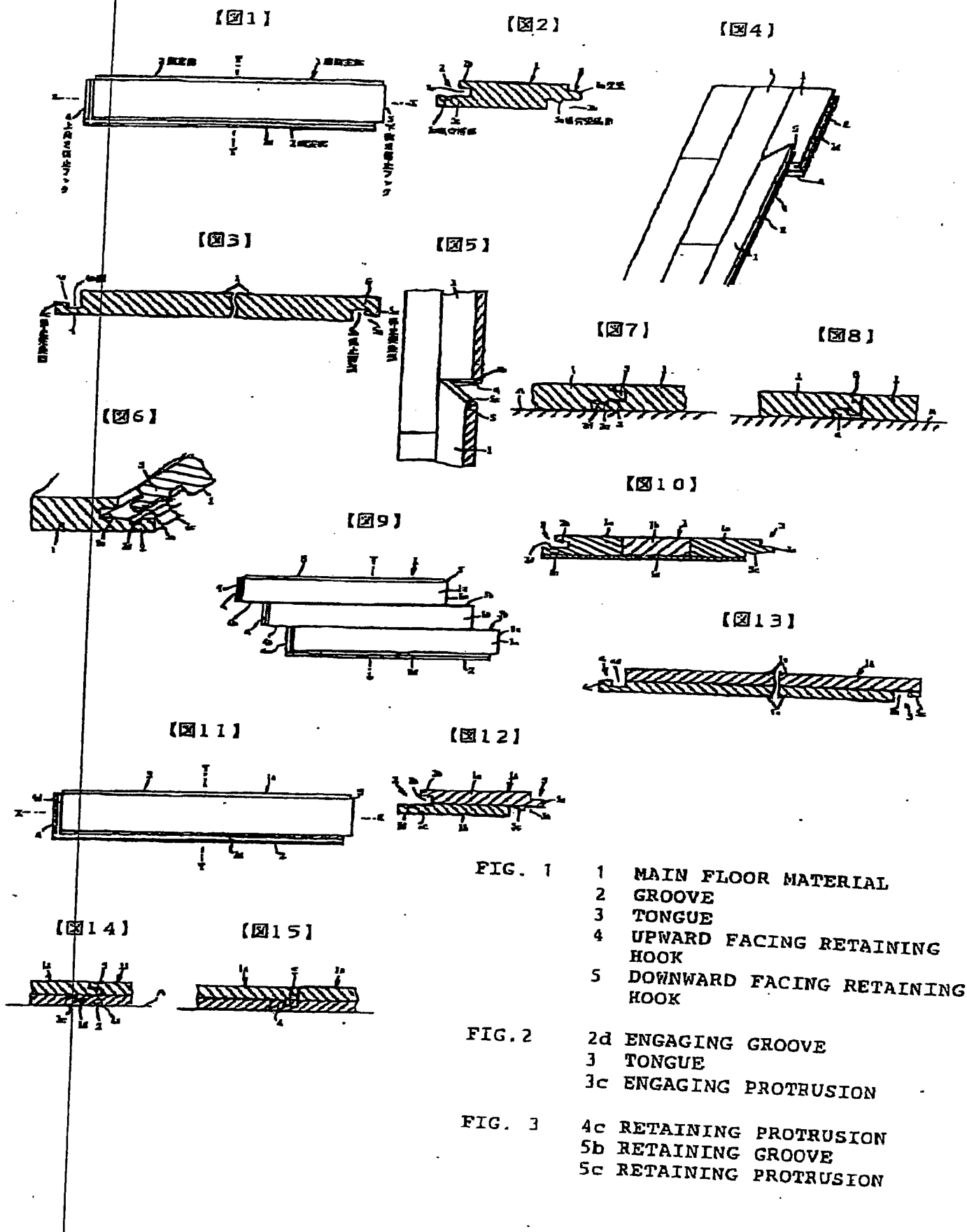

【図1】

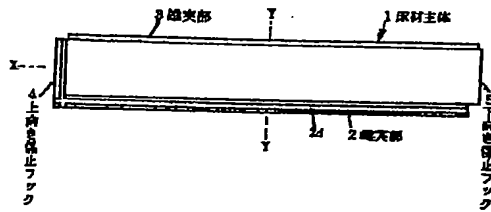

【図2】

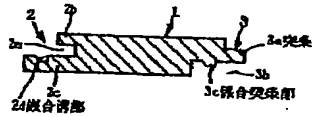

【図4】

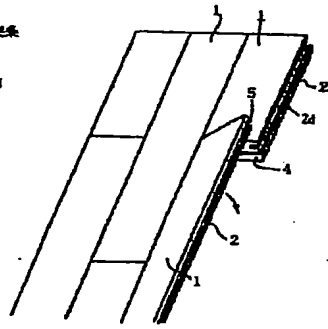

【図3】

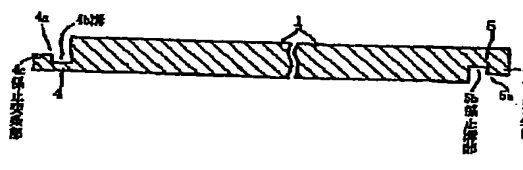

【図5】

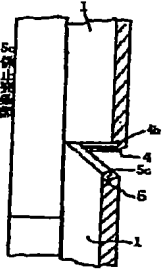

【図7】

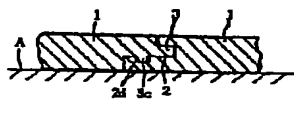

【図8】

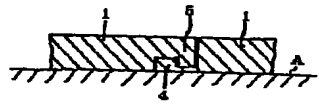

【図6】

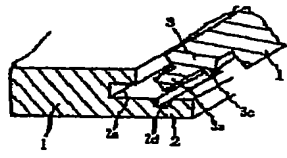

【図10】

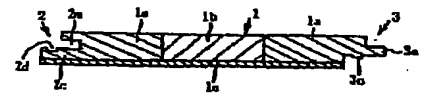

【図9】

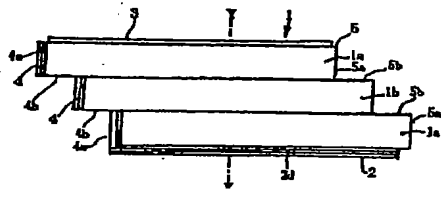

【図13】

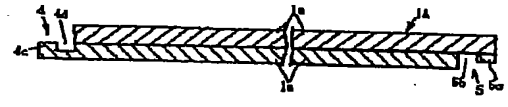

【図11】

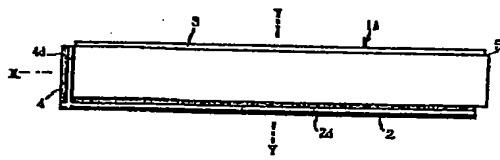

【図12】

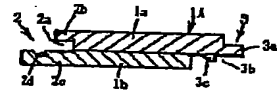

【図14】

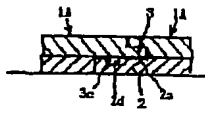

【図15】

